

KeyGree

# MIG USER'S MANUAL

---

*Do it easy, comfortable, trustable.*

# MODELS

MIG-350/MIG-500/MIG-630/MIG-1000



---

## PREFACE

Dear users, thank you for using our inverter welder. For your correct operation of our product, please read this manual carefully before use and keep it properly for future reference.

### **SPECIAL NOTICE:**



1. When the welder is placed on an inclined plane, care should be taken to prevent it from tipping over;
2. As the protection level of this welder series is IP21S, it is not suitable for use in the rain;
3. The product conforms to GB15579 standard;
4. This product complies with the electromagnetic compatibility requirements for type A equipment.

The Instruction Manual is subject to change without prior notice.

---

# SAFETY PRECAUTIONS

## Precautions for Installation

	<p><b>ELECTRIC SHOCK!!!</b></p> <ul style="list-style-type: none"><li>● Install the earthing device according to the applicable standard.</li><li>● Do not touch live parts while bare skin or wearing wet gloves or clothes.</li><li>● Insure you to insulate appearance with the ground and the work piece.</li><li>● The cover plate must be covered before power on, otherwise it may cause electric shock.</li><li>● Make sure that your workstation is in a safe state.</li></ul>
	<p><b>FIRE!!!</b></p> <ul style="list-style-type: none"><li>● Please install the product on non-combustible objects, otherwise there is a risk of fire.</li><li>● Do not put combustible materials nearby, otherwise there is a risk of fire.</li></ul>
	<p><b>EXPLOSION HAZARD!!!</b></p> <ul style="list-style-type: none"><li>● Do not install the product in an environment containing explosive gas, otherwise there is a risk of an explosion.</li></ul>



### Replacing parts and components may cause danger

- Only professionals can replace the parts.
- Do not drop foreign objects such as thread ends, screws, gaskets and metal bars into the welder when replacing parts.
- After replacing the circuit board, the internal connection of the welder shall be correct before the welder can be operated, otherwise there is a risk of property damage.



## Precautions for Use

### **Fume/smoke dust — It may be harmful to health.**

- Welding would produce lots of gases and fumes that are harmful to the body. Avoid inhalation into the respiratory tract.
- Keep your head away from fumes while welding. Adopt adequate ventilation or exhaust facilities to keep smoke and gas away from the breathing area, and maintain good ventilation in the working environment.

### **Arc radiation — It may damage your eyes and burn your skin.**

- Use an appropriate welding mask and wear protective clothing to protect your eyes and body.
- Use an appropriate mask or curtain to protect bystanders from harm.

### **Magnetic field will affect pacemakers.**

- The electric current from any conductor will produce electromagnetic fields. Welding operators with cardiac pacemakers should consult a doctor before welding.
- Stay away from power sources as much as possible to minimize the impact of electromagnetic fields.

### **Improper use and operation may cause fire or explosion.**

- Sparks from welding may cause fire. Please confirm that there is no flammable material near the welding station and pay attention to fire safety.
- Ensure that there is a fire extinguishing device nearby and a trained person who can use fire extinguishers proficiently.
- Do not weld sealed containers.
- Do not use the welder for thawing pipelines.

### **Hot workpiece may cause severe burns**

- Do not touch hot workpieces with bare hands.
- Let the welding gun cool down for a while after continuous operation.

### **Noise — Excessive noise is harmful to hearing.**

- Protect your ears. Use ear shields or other hearing protectors.
- Warn bystanders of the potential damage to their hearing caused by noise.

### **Moving parts may cause personal injury**

- Avoid moving parts (such as fans).
- Protective devices such as doors, panels, covers and baffles must be tightly closed and put in the right place.

### **Fault — Seek professional help when in trouble.**

- If you encounter difficulties during installation and operation, please follow relevant contents of this manual for troubleshooting.
- If you do not fully understand it after reading, or if you cannot solve the problem according to the guidelines in this manual, you should contact your supplier immediately and seek professional help.

## Precautions for Scrapping

### **When scrapping the welder, please note:**

- The electrolytic capacitor of the main circuit and the electrolytic capacitor on the printed board may explode when burned.
- The plastic parts such as front panels will produce toxic gas when burned.
- Please dispose of it as industrial waste.

# CONTENTS

<b>Chapter I Product Overview</b>	
1.1 Model Explanation.....	01
1.2 General Technical Parameters.....	01
1.3 Descriptions of Functions and Features.....	02
1.4 System Features.....	03
<b>Chapter II Installation and Wiring</b>	
2.1 Installation Requirements.....	04
2.2 Electrical Connection.....	04
2.3 Welding Preparations.....	08
2.4 Do's and Don'ts.....	08
<b>Chapter III Operating Instructions</b>	
3.1 Operating Methods.....	09
3.2 Panel Functions.....	10
3.3 Use Method of Basic Welding Functions.....	12
3.4 Wire Feeder Panel Functions.....	13
3.5 Welding Current Setting.....	14
3.6 Welding Speed Selection.....	14
3.7 Selection of the Dry Extension Length of Welding Stick.....	14
3.8 Selection of Co <sub>2</sub> Gas Flow Rate.....	14
3.9 Method to Use Extended Output Cables.....	15
3.10 Welding Parameters Cheat Sheet.....	15
<b>Chapter IV Maintenance</b>	
4.1 Routine Maintenance.....	17
4.2 Regular Inspection.....	20
<b>Chapter V Troubleshooting</b>	
5.1 Welder Failure and Problems in Welding Procedure.....	22
5.2 After Sales Service.....	23

---

# Chapter I Product Overview

## 1.1 Model explanation

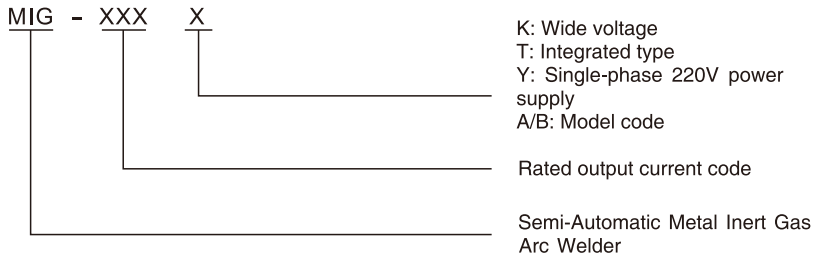

Fig. 1-1 Model Explanation

## 1.2 General technical parameters

See Table 1-1 for the general technical parameters of the welder.

Table 1-1 General Technical Parameters

Item	Model Description			
	MIG-350	MIG-500	MIG-630	MIG-1000
Rated Input Voltage(V)	3P 380V	3P 380V	3P 380V	3P 380V
Frequency(Hz)	50/60	50/60	50/60	50/60
Max Input Current(A)	23.3	43	60	105.5
Rated Input Capacity(KVA)	15.5	27.5	39.8	69.4
No-Load Voltage(V)	68	72	78	72
Adjustment Current range(A)	40-350	40-500	40-630	40-1000
Rated Working Voltage(V)	32	39	44	44
Duty Cycle(%)	60	60	60	80
MMA function	YES	YES	YES	YES
Wire Feeder	separated type	separated type	separated type	separated type
Wire Diamter(MM)	0.8/1.0/1.2	1.0/1.2/1.6	1.0/1.2/1.6	1.6/2.0/2.8
Protection classification	IP21S	IP21S	IP21S	IP21S
Net Weight (KG)	30.9	39.15	45	85
Machine Dimensions(MM)	540×260×490	620×390×330	650×310×600	685×360×965

### 1.3 System composition

1) Composition (Taking MIG-500A separate type for example)

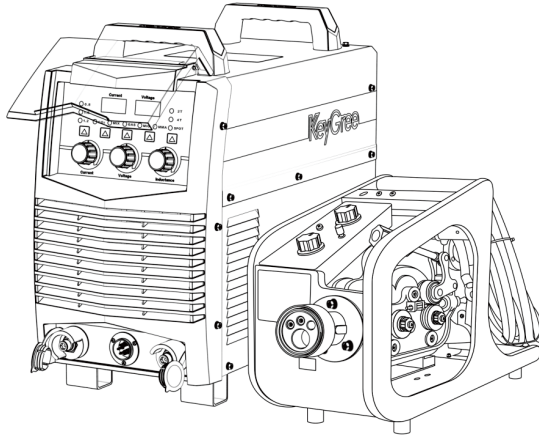

Table 1-3 Factory Configuration List

1. Instruction Manual
2. Warranty Registration
3. Certificate of Compliance
4. Wrench
5. One pair of quick plugs

## 1.4 Description of functions and features

MIG series is our inverter welder manufactured with advanced inverter technology, which is a more mature and stable product series.

- Superior IGBT inverter technology, frequency up to 28KHz, smaller volume, lighter weight, higher efficiency, and more energy-saving;
- Closed-loop feedback control, stable output voltage and strong resistance to grid voltage fluctuation ( $\pm 10\%$ );
- Unique welding dynamic characteristic control circuit, stable welding arc, few spatter, beautiful molding and high welding efficiency;
- Whole series digital design, capable of adjusting the parameters in the program according to different workpieces and welding technology;
- Having the ability to eliminate the molten droplets at the end of the wire after welding, supplemented by high no-load and slow wire feeding functions to improve the success rate of one-time arc striking;
- All separate types with self-locking/non-self-locking (crater on/off) functions, suitable for different welding needs;
- Having both gas shielded (arc) welding and manual welding functions;
- Used for carbon dioxide gas ( $\text{CO}_2$ ) or mixed gas shielded (MA/MIG) welding, the shielding gas composition of  $\text{CO}_2$ , MAG, MIG welding methods corresponding in order: 100%  $\text{CO}_2$ , 80% Ar + 20%  $\text{CO}_2$ , and 98% Ar + 2%  $\text{CO}_2$ ;
- Suitable for welding common low carbon steel, stainless steel and their alloys;
- Suitable for solid wires and tubular flux-cored wires.

## 1.5 System characteristics

### 1) Duty circle

Rated load duration rate refers to the percentage of the normal working time of the welder in the rated maximum output current state and the period, with 10 minutes as a period. The specified duty cycle is 60%. Continued use of the welder beyond the rated load duration will cause it to overheat, and frequent use beyond the rated load will accelerate aging or even cause damages.

Output characteristics: The static external characteristics of this welder series are constant voltage in gas shielded welding mode and constant current in manual welding mode.

# Chapter II Installation and Wiring

## 2.1 Installation requirements

Environmental requirements: When selecting the installation environment, the following should be noted:

- Avoid installation in places with much dust and metal powder;
- Strictly prohibited to install in places with corrosive and explosive gases;
- Ambient temperature range: working: -10 to +40°C; transportation and storage state: -25 to +55°C;
- Do not place the welder on a table top with an inclination greater than 15°;
- Put the welder at a dry and ventilated location and protect it from direct sunlight or rain;
- Keep the welding site from wind, and use wind shield when necessary in case of affecting the welding technology.

### Installing Space Requirements

The welder is at least 20 cm away from the wall, and two welders should be placed side by side at a distance of more than 30 cm.

## 2.2 Electrical connection

### Attention:

- 1) Please have the connection performed by a qualified professional electrical operator.
- 2) Electrical connection must be performed with the switch of the distribution box disconnected to ensure safety.
- 3) Do not touch the live parts with wet objects.
- 4) Do not place heavy objects on the cable.
- 5) Tap water pipes and building steel reinforcement are likely to be inadequately grounded. Do not use them for connecting protective earth wires.

### 2.2.1 Manual welder installation and commissioning

#### 1) How to install

- ① Turn the manual welding/gas shielded welding on the front panel of the welder to the manual welding position.
- ② Connect the cable with welding clamp to the positive quick outlet under the front panel of the welder and tighten it with an Allen wrench.
- ③ Plug the cable with earth clamp into the negative quick outlet under the front panel of the welder, tighten it with an Allen wrench, and connect the earth clamp to the workpiece.
- ④ Disconnect the switch of the distribution box (user equipment), connect the power cord on the rear panel of the welder to the output terminal of the distribution box, and connect the yellow and green wires in the power cord to the ground.

### Prompt:

Connect the cable with welding clamp in the positive quick outlet and the cable with earth clamp in the quick outlet to the workpiece. This method is called DC reverse method. If the cable with earth clamp in the positive quick outlet is connected to the workpiece while that with clamping clamp in the negative quick outlet, it is called DC positive method. Operators can also choose the DC positive connection method according to the base metal and electrode. In general, DC reverse method is recommended for basic electrodes (i.e., positive electrode). As for acid electrodes, there is no special requirement.

## 2) Operating method

① After correct installation as above, close the air switch on the rear panel to start up the welder. At the same time, the voltmeter shows the voltage as no-load voltage and the ammeter shows the preset current. If the current knob is adjusted, the current setting value will change between minimum and maximum.

② Pre-adjust the welding current according to the electrode specification and type, grip the electrode, and start welding by means of short circuit arch strike. The welding current can be adjusted according to welding needs and the welder's habit or with reference to Table 2-1.

Table 2-1 Manual Welding Technology/Procedure Cheat Sheet

Electrode Specification (mm)	Recommended Welding Current (A)
2.0	60~100
2.5	80~120
3.2	108-148
4.0	140~200
5.0	180~260
6.0	220~300

Round carbon rod (mm)	Recommended welding current (A)
6	350-450
8	450-550
10	50-630
12	750-850

### 3) Connection of the wire feeding end

Connecting steps:

- ① Fasten the six-core control cable, gas tube and positive output welding cable using the end snap of the wire feeder.
- ② Connect the six-core aviation plug of the control cable to the six-core aviation outlet on the fixing plate of the wire feeder and fix it.
- ③ Connect the gas tube to the copper connector on the wire feeder fixing plate and screw up the hose clamp of the gas tube with a tool.
- ④ Fix the positive output welding cable to the stud on the base plate of the wire feeder and tighten it.
- ⑤ End of connection.

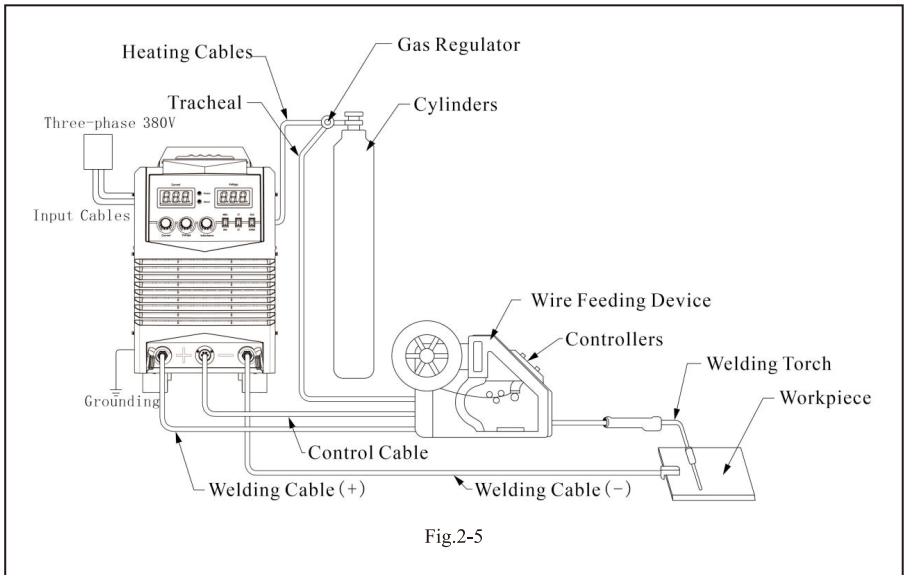

#### ATTENTION

- The gas bottle should be kept away from high temperature areas and should avoid exposure to the sun in case the air pressure inside the bottle increases to cause accidents.
- It is forbidden to knock the gas bottle by force or place it upside down.
- Since the arc light of gas shielded welding is much stronger than that of manual welding, be sure to put on a mask to block the light before operation.



Connection of **welding torch** and wire feeder  
 Detailed connecting steps are given in the figure below.

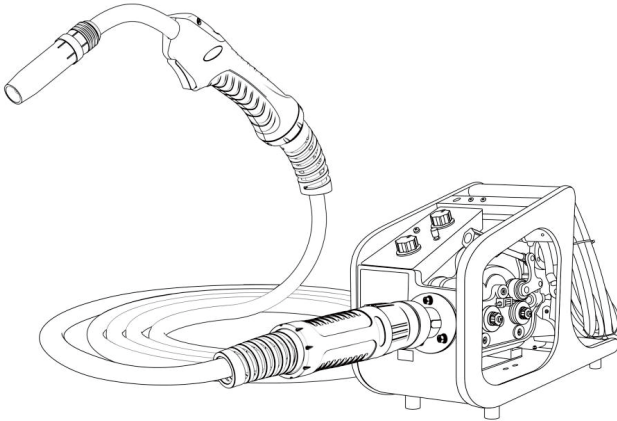

**4) Connection of earth clamp and cable (earth wire)**

Connect the other end of the earth clamp cable to the workpiece reliably and connect the workpiece with an appropriately sized earthing cable.

**5) Connection of power cord input side cable**

- ① Disconnect the switch of the distribution box (user equipment).
- ② Connect the welder input cable to the output terminal of the distribution box switch to finish cable connection.

**6) Please refer to Table 2-7 for the requirements for input power cable and earth wire.**

Table 2-7 Requirements for Input Power Cable and Input Earth Wire

Size	MIG-350 (all 350 models)	MIG-500 (all 500 models)	MIG-630 heavy industry	MIG-1000
Switching capacity	63	63	100	125
Cross-sectional area of national standard copper-core power cord (mm <sup>2</sup> )	4	6	6-10	10-16
Earthing copper-core cable Cross-sectional area (mm <sup>2</sup> )	4	6	6	10

## 2.3 Welding preparations

### 2.3.1 Safety precautions

#### Protective equipment

- To prevent gas poisoning and asphyxiation, dust poisoning and other hazards, please use exhaust equipment or respiratory protection gears as required.
- When welding or supervising welding, use safety goggles or protective gears with sufficient light shade.
- To protect your eyes from spatter and welding slag, wear protective spectacles.
- Wear leather gloves, long-sleeved clothes, foot protectors, aprons, and other protective gears.
- Set up a protective barrier around the welding place to prevent the arc light from injuring others.
- When the noise is loud, please use sound insulation apparatus.
- Use ventilation fan to change the air or take wind protection measures when it is windy outside to prevent the wind from blowing directly on the electric arc to cause poor welding.

Please refer to Table 2-8 for the selection of CO2/MAG welding mask light filters.

Table 2-8 Selection of Welding Mask Light Filters

Number	Electric arc welding and cutting operations
1.2/1.4/1.7	Anti-side light and anti-stray light
3/4	Auxiliary worker
5/6	Electric arc operation below 30A
7/8	Electric arc operation at 30-75A
9/10/11	Electric arc operation at 75-200A
12/13	Electric arc operation at 200-400A
14	Electric arc operation above 400A

## 2.4 Do's and don'ts

- 1) The installation area should be firm enough to support the welder.
- 2) It is forbidden to install the welder in places where water splashes may be generated, such as water pipes.
- 3) Welding operations must be performed in a relatively dry environment where the air humidity is normally not greater than 90%.
- 4) The ambient temperature shall be between -10°C and +40°C.
- 5) Do not perform welding in dusty or corrosive gas-containing areas.
- 6) Do not place the welder on a table top with an inclination greater than 15°.

The welder has been installed with overvoltage, overcurrent and overheating protective circuits. When the grid voltage, output current and internal temperature exceed the set standards, the welder will stop working automatically; but excessive use (such as excessive voltage) will still cause damage to the welder, so the following matters shall be noticed:

- **Ensure good ventilation**

When the welder is in operation, there is a large working current passing through, and natural ventilation cannot meet the cooling requirements of the welder, so there is a fan inside to effectively cool the welder to make it work smoothly. Check whether the ventilated place is covered or blocked. Make sure the distance between the welder and surrounding objects is less than 0.3m.

- **Prohibit excessive voltage**

In general, the automatic voltage compensation circuit inside the welder will ensure that the welding current is kept within the allowable range. If the supply voltage exceeds the allowable value, it will damage the welder.

- **Prohibit overload**

Operators shall use the welder according to its allowable load duration rate and maintain the welding current within the maximum allowable load current. Current overload will remarkably shorten the life of the welder or even burn it.

If the welder exceeds the standard load duration rate in working, it may suddenly enter the protection state and stop working. This indicates that once the standard load duration rate is overtaken, it will heat up to trigger the temperature control switch to stop the welder, and the yellow indicator light on the front panel is on at the same time. In this case, do not pull out the power plug. Let the fan cool down the welder. When the yellow indicator light is off and the temperature drops to the standard range, start welding.

## **Chapter III Operating Instructions**

### **3.1 Operating methods**

- 1) After correct installation, turn on the power switch and push the power switch in the "ON" position. Then, the power indicator light will be on and the fan inside the welder will start rotating.
- 2) Open the valve of the gas bottle and adjust the flow meter to the desired flow rate. Select the torch contact tube aperture according to the wire diameter.
- 3) According to the thickness of the workpiece to be welded and the welding technology, match the "voltage adjustment" knob and the "current adjustment" knob to the corresponding positions.
- 4) The "inductance adjustment" knob can change the softness and hardness of the arc, and can be regulated to the appropriate position as needed.

### 3.2 Panel functions

- 1) Take the separate type welder MIG-500 for heavy industry purpose as an example Front panel operation is shown in Figure 3-5.

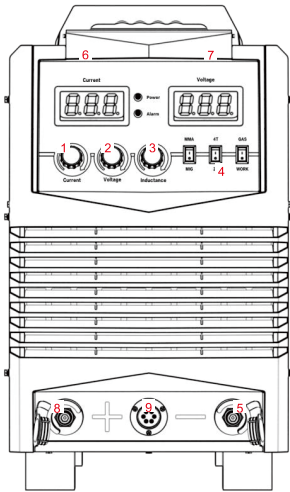

Item	Part Name	Part Function
1	Current control knob	Adjusting the output current magnitude
2	Voltage adjustment knob	Adjusting the welding voltage level
3	Inductance adjustment knob	Adjusting inductance
4	Function button area	Selecting buttons for various functions
5	Negative terminal	Connecting the earth wire
6	Current digital meter	Displaying welding current
7	Voltage digital meter	Displaying welding voltage
8	Positive terminal	Connecting wire feeder
9	Aviation outlet interface	Connecting six-core control cable plug

Rear panel operation is shown in Figure 3-6.

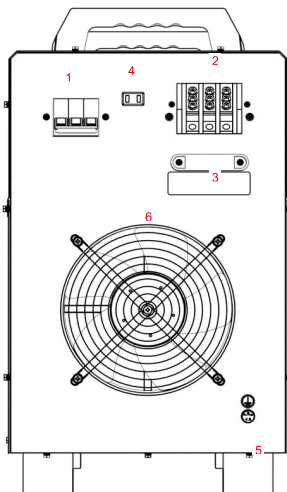

Item	Part Name	Part Function
1	Power switch	Controlling input power ON and OFF
2	Junction box	Protective base plate and supporting machine
3	Input sign	Power input
4	Heating outlet	Forcing air cooling and heat dissipation
5	Ground screw	Connecting the power cord earth wire
6	Fan guard	Air duct inlet to protect the fan

The operation of the function button area is shown in Figure 3-7 (take MIG-500 as an example)

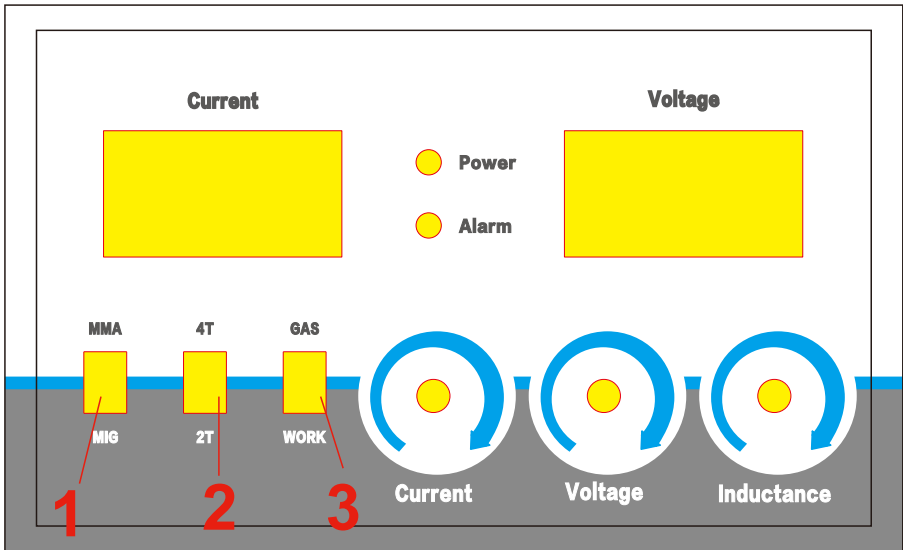

Item	Button Name	Button Function
1	MMA/MIG	Manual welding/gas shield welding
2	2T/4T	Self-locking(4-step)/non-self-locking(2-step)
3	GAS/WORK	Gas check/Welding status

### 3.3 Use method of basic welding functions

The "function switching" on the panel and the torch switch allow welding in two ways: crater on/self-locking and crater off/non-self-locking with simultaneous operation of the torch switch.

#### 3.3.1 Operating procedures for crater welding

1) Feature description:

- The main feature of crater welding is the possibility of filling the depression at the end of the welding to facilitate the joining of the starting/beginning points of a weld (seam) in multiple succession;
- Crater welding is most suitable for the welding of medium and thick plates.

1) **Operating procedures:**

- Turn the panel function switching button to the self-locking position;
- Enter the welding preparation state, press the torch switch to start feeding gas and enter the advance feeding state; (0.3S) later when welding voltage appears, begin to slowly feed the wire into the arc initiation state; after successful arc striking, the feeding speed becomes normal and welding current forms; then, release the torch switch to weld into the self-locking state; at the same time, adjust the "welding voltage adjustment button" and "welding current adjustment button" of the wire feeder to ensure the best welding effect;
- When welding to the end point, press the torch switch again, that is, to enter the arc stopping adjustment state; at this time, set the arc stopping voltage and current by adjusting the "arc stopping voltage adjustment button" and "arc stopping current adjustment button" on the welding power supply panel (or pre-adjusted to the demand value, generally 60% to 70% of the normal welding current), so as to be able to control and regulate the crater effect at the end of filling pass; again, release the torch switch, immediately stop feeding to enter the back burn state. At this time, the welding voltage becomes smaller as back-burn voltage and the welding current is zero. At the end of arc breaking burn-back, feeding stops and the entire welding process is complete.

2) **Keywords description:**

- **Arc starting/stopping (self-locking, non-self-locking):** In addition to very low current welding, a pit will form generally at the end of welding (tail end of the weld seam), which called "crater" in terminology. Crater formation is derived from arc downforce and metal condensation shrinkage. In general, the higher the welding current, the larger the crater. In welded components, the crater is very likely to cause welding defects, so it is required to be as small as possible. We call the method of filling craters "crater fill", and the standard value of the current setting is 60% to 70% of the welding current. At the end of welding, the torch switch can be operated to change to a lower arc stop welding program than the welding current, i.e., "self-locking/crater on", while "non-self-locking/crater off" means that there is no control program set to fill the crater, and the torch switch is operated to end the welding at the normal welding current value.
- **Arc generation slow feeding speed:** The process of reducing the wire feeding speed during the initial welding period to be lower than the normal wire feeding speed set as per the welding conditions in order to obtain a stable arc is called slow feeding arc generation control, whereas the reduced speed is called slow feeding speed.
- **Burn-back time:** After the welding is finished, even if the torch switch is turned off, the wire feeder does not stop immediately due to the inertia of the motor, so there is often excess welding stick protruding out of the torch. This will cause the wire to adhere to the workpiece or cause difficulty in generating the arc next time. To eliminate this undesirable factor, it is necessary to process the welding power source internally so

that after the torch switch is turned off, a certain output voltage is still maintained for a short time to burn the welding stick. This processing time is called burn-back time, and the setting of this time period varies depending on the welding conditions, output cable lengthening, and resistance of the wire feeding hose.

### 3.3.2 Operating procedures for crater-free welding

#### 1) Feature description:

- For crater-free welding, press the torch switch to start welding and release it to stop welding;
- Crater-free welding is suitable for fixed-position welding, spot welding, and thin plate welding;
- Unlike crater welding, crater-free welding does not involve the process of crater welding apart from the different in operating procedures.

#### 2) Operating procedures:

- Turn the panel function switching button to the non-self-locking position;
- Enter the welding preparation state, press the torch switch to start feeding gas and enter the advance feeding state; (0.3S) later when welding voltage appears, begin to slowly feed the wire into the arc initiation state; after successful arc striking, the feeding speed becomes normal and welding current forms; then, keep the torch switch pressed while adjusting the "welding voltage adjustment button" and "welding current adjustment button" of the wire feeder to ensure the best welding effect.

## 3.4 Wire feeder panel functions

Separate type wire feeder front panel

Each operation of the front panel is shown in Figure 3-8

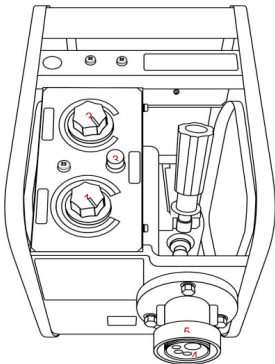

Item	Part Name	Part Function
1	Feeding speed adjustment	Adjusting the feeding speed (current regulation)
2	Voltage adjustment knob	Adjusting the welding voltage level
3	Jog feeding switch	Controlling wire feeding
4	Gas-out joint	Connecting the torch inlet pipe
5	Torch interface	Connecting the gas shielded welding torch

### 3.5 Welding current setting

The selection of welding current and arc voltage directly affects the stability of the welding process, welding quality and productivity. In order to ensure the welding quality, a good match between welding current and arc voltage is required. The selection is usually based on the wire diameter and the required drop transfer and productivity. The current setting in the table below can be referred to for commonly used welding current and voltage use range.

For different working conditions, please refer to the "Welding Parameters Cheat Sheet" for welding.

Table 3-9 Recommended Current and Voltage Ranges for CO<sub>2</sub> Welding

Wire diameter	Short circuiting transfer		Diving current transfer	
	Current (A)	Voltage (V)	Current (A)	Voltage (V)
0.8	60-100	17-19	200-500	26-40
1.0	80-120	18-21	200-600	27-40
1.2	100-150	19-23	300-700	28-42
1.6	140-200	20-24	500-800	32-44

### 3.6 Welding speed selection

The main considerations are welding quality and productivity. Welding speed is too fast, and protection effect is poor, increasing the cooling rate while reducing the toughness of the weld, which is not conducive to weld forming; welding speed is too slow, it is easy to burn through the weld and thicken the weld microstructure. Generally, the actual welding speed does not exceed 50 cm/min.

### 3.7 Selection of the dry extension length of welding stick

The longer the dry extension of the stick, the shallower the melting, and the faster the stick melts to increase productivity; but if the dry extension is too long, the stick is easy to fuse and spatter, making the welding process unstable. It is generally 10-12 times the stick diameter.

### 3.8 Selection of CO<sub>2</sub> gas flow rate

The main consideration is protection effect. In addition, inside fillet welding is better protected than outside fillet welding and the flow rate should be low. Refer to Table 3-9 below for specific values.

Table 3-10 Selection of CO<sub>2</sub> Gas Flow Rates

Welding method	Fine wire CO <sub>2</sub> welding	Thick wire CO <sub>2</sub> welding	Thick wire current CO <sub>2</sub> welding
CO <sub>2</sub> flow rate (L/min)	5-15	15-25	25-50



### 3.9 Method to use extended output cables

All the separate type gas shield welders produced by our company allow appropriate extension of the connection cable between the "+" positive output of the welding power source and the wire feeder provided that the following rules are observed:

- When extending the cable, you must use a cable that meets national standards and has a larger cross-sectional area than the normal one, because extending the cable will correspondingly increase the cable resistance and moreover, increasing the cable voltage drop is not conducive to welding operations; the smaller the cross-sectional area of the cable, the greater the impact.
- When extending the cable, still the shorter the better.
- When extending the cable, the cable must be straightened.

### 3.10 Welding parameters cheat sheet

The selection of welding current and voltage directly affects the stability of the welding process, welding quality and productivity. In order to ensure the welding quality, a good match between welding current and arc voltage is required. The selection is usually based on the wire diameter and the required drop transfer form and productivity.

The use range of commonly used welding current and electric arc voltage are covered in the following Tables I and II.

In the actual welding process, please make corrections to find the proper welding conditions according to the workpiece to be welded, the welding position, etc.

Table I

Item		Plate Thickness (mm)	Leg length (mm)	Wire diameter (mm)	Welding Current (A)	Welding Voltage (V)	Welding Speed (cm/min)	Dry extension (mm)	Gas flow rate (L/min)
Flat fillet welded T-joint	Low speed welding condition	1.0	2.5-3	0.8	70-80	17-18	50-60	10	10-15
		1.2	3-3.5	1.0	85-90	18-19	50-60	10	10-15
		1.6	3-3.5	1.0,1.2	100-110	18-19.5	50-60	10	10-15
		2.0	3-3.5	1.0,1.2	115-125	19.5-20	50-60	10	10-15
		2.3	3-3.5	1.0,1.2	130-140	19.5-21	50-60	10	10-15
		3.2	3.5-4	1.0,1.2	150-170	21-22	45-50	15	15-20
		4.5	4.5-5	1.0,1.2	180-200	23-24	40-45	15	15-20
		6	5-5.5	1.2	230-260	25-27	40-45	20	15-20
		8、9	6-7	1.2,1.6	270-380	29-35	40-45	25	20-25
	12	7-8	1.2,1.6	300-380	32-35	35-40	25	20-25	
	High speed condition welding	1.0	2-2.5	0.8	140	19-20	150	10	15
		1.2	3	0.8	140	19-20	110	10	15
		1.6	3	1.0,1.2	180	22-23	110	10	15-20
		2.0	3.5	1.2	210	24	110	15	20

Flat fillet welded T-joint	High speed condition welding	2.3	3.5	1.2	230	25	100	20	25
		3.2	3.5	1.2	260	27	100	20	25
		4.5	4.5	1.2	280	30	80	20	25
		6	5.5	1.2	300	33	70	25	25

Table II

Item		Plate Thickness (mm)	Leg length (mm)	Wire diameter (mm)	Welding Current (A)	Welding Voltage (V)	Welding Speed (cm/min)	Dry extension (mm)	Gas flow rate (L/min)
Flat fillet welded overlap joint (sheet)	Low speed welding condition	0.8		0.8	60-70	16-17	40-45	10	10-15
		1.2		0.8	80-90	18-19	45-50	10	10-15
		1.6		0.8	90-100	19-20	45-50	10	10-15
		2.3		0.8	100-130	20-21	45-50	10	10-15
				1.0,1.2	120-150			10	10-15
			3.2	1.0,1.2	150-180	20-22	35-45	10-15	10-15
		4.5	1.2	200-250	24-26	40-50	10-15	10-15	
	High speed welding	2.3-3.2		1.2	220	24	150	15	25
			300		26	250			
Crossover joint sheet	Low speed welding	1.6		0.8	65-75	16-17	40-45	10	10-15
		2.3		0.8	80-100	19-20	40-45	10	10-15
		3.2		1.0,1.2	130-150	20-22	35-40	15	10-15
		4.5		1.0,1.2	150-180	21-23	30-35	15	10-15
		Plate Thickness (mm)	Root gap G (mm)	Wire diameter (mm)	Welding Current (A)	Welding Voltage (V)	Welding Speed (cm/min)	Dry extension (mm)	Gas flow rate (L/min)
Type I Butt welding	Low speed welding condition	0.8	0	0.8	60-70	16-16.5	50-60	10	10
		1.0	0	0.8	75-85	17-17.5	50-60	10	10-15
		1.2	0	0.8	80-90	17-18	50-60	10	10-15
		1.6	0	0.8	95-105	18-19	45-50	10	10-15
		2.0	0-0.5	1.0,1.2	110-120	19-19.5	45-50	10	10-15
		2.3	0.5-1	1.0,1.2	120-130	19.5-20	45-50	10	10-15
		3.2	1-1.2	1.0,1.2	140-150	20-21	45-50	10-15	10-15
		4.5	1-1.5	1.0,1.2	170-185	22-23	40-50	15	15
	6	Exterior	1.2-1.5	1.2	230-260	24-26	40-50	15	15-20
		Interior	1.2-1.5	1.2	230-260	24-26	40-50	15	15-20

Type I Butt welding	Low speed welding condition	9	Exterior	1.2- 1.5	1.2	320-340	32-34	40-50	15	15-20
			Interior	1.2- 1.5	1.2	320-340	32-34	40-50	15	15-20
	High speed welding condition		0.8	0	0.8	89	16.5	120	10	15
			1.0	0	0.8	100	17	120	10	15
			1.2	0	0.8	110	18	120	10	15
			1.6	0	1.0,1.2	160	19	120	10	15
			2.0	0	1.0,1.2	180	20	80	15	15
			2.3	0	1.0,1.2	200	22	100	15	20
		3.2	0	1.2	240	25	100	15	20	

## Chapter IV Maintenance

### 4.1 Routine maintenance

**ATTENTION: Routine inspection must be carried out after switching off the power supply of the distribution box and the welder (except for visual inspection that does not require contact with the conductor) to avoid personal injury like electric shock and burn.**

#### Notice for Use

- 1) Routine inspection is vital for the high use performance and safe operation of the welder.
- 2) The routine inspection shall be conducted according to items in the table below and cleaning or replacement shall be conducted if necessary.
- 3) For the purpose of ensuring the high performance of the welder, the components provided or recommended by our company shall be used for the replacement of components.

Table Routine Inspection Contents of the Welder

Item	Inspection Requirements	Remarks
Front panel	Check whether parts and components are damaged or loose; Check whether the quick output socket is tightened; Observe whether the indicator light is on.	The quick outlet terminal on the front panel is the item of regular inspection. In case of any nonconformity, the interior of the welder shall be checked, the fastener supplemented, or the components replaced.
Rear panel	Check whether the input power cord and the buckle are intact and whether the air inlet is clear and free of foreign objects.	
Upper cover	Check whether the bolt is loose.	In case of nonconformity, the fastener shall be supplemented or the component replaced.
Bottom plate	Check whether the screws on the bottom plate are loose.	
Routine inspection	Check whether there is color fading or overheating; Check whether the sound of the fan is normal when the welder is working; Check whether there is odor, abnormal vibration and noise when welding.	If abnormal conditions occur, check the inside of the welder.

Table Routine Inspection of Cables

Item	Inspection Requirements	Remarks
Earth wire	Check whether the safety earth wire falls off, including the working earth wire and the welder earth wire.	In case of nonconformity, the fastener shall be supplemented or the component replaced.
Welding cable	Check whether the insulation layer of the cable is worn or damaged or whether the live parts are exposed; Check whether the cable is stretched by abnormal external force; Check whether the cable is firmly connected with the workpiece.	To ensure safe and normal welding, appropriate methods should be used for comparison inspection according to the conditions on the job site.

Table Routine Inspection Content of Torch







Item	Inspection Requirements	Remarks
Nozzle	Check whether the installation is firm and whether the front end is deformed	Cause of pores
	Check for attached splashes	Cause of torch burnout (The effective way is to use anti-spatter agent)
Wire guide	Check whether it is firmly installed	Cause of torch thread damage
	End damage, hole wear and blockage	Cause of unstable arc or arc breakage
Feeding hose	Check the size of the feeding hose extension	If smaller than 6 mm, replace it. If the size of the protruding part is too small, it will lead to unstable arc. (When replacing the wire feeding tube, it is best to make the extension slightly longer than specified)
	Check whether the wire diameter coincides with the inner diameter of the wire feeding tube	The cause of unstable arc is mismatching. Replace the wire feeding tube with a suitable one.
	Local bending and elongation	Cause of poor wire feeding and arc instability. Please replace it.
	Dirt in wire feeding tube and clogging of wire plating residue	Leading to poor wire feeding and arc instability (wipe off with kerosene or replace with a new wire feeding tube)
	Broken wire feeding tube, worn O-ring	Likely to cause splatter; Breakage of heat-shrink tubes, replace with a new wire feeding tube; wear of O-ring, replace with a new one
Gas distributor	Forgot to insert or hole blockage, or mismatching with the components purchased from other manufacturers	Likely to cause welding defects (spatter, etc.) and burn out the torch body (arc inside the body), etc. due to poor gas shielding. Please deal with them correctly.

Table Routine Inspection Content of Wire Feeder

Item	Inspection Requirements	Remarks
Handle	Check whether the pressure handle is set to the proper pressure indication line	Resulting in unstable feeding and arc
Wire liner	Check whether the wire liner mouth and the side of the wire feed roll accumulate cutting powder and debris	Remove the cutting powder and debris and find out the cause to eradicate it
	Check whether the wire diameter coincides with the inner diameter of the wire liner	When it does not match, the arc is unstable or produces cutting powder and debris
	Check whether the center of the wire liner mouth and the slot center of the wire feed roll are consistent (by visual inspection)	Misalignment leads to the generation of cutting powder and arc instability.
Wire feed rolls	Check whether the wire diameter and the nominal diameter of wire feed roll are consistent Check the slot of the wire feed roll for blockage	It may generate cutting powder, clog wire feeder, and cause unstable arc; if abnormalities occur, replace with new products
Pressurized roller	Check the smoothness of rotation, wear of wire pressurized surface, and narrowing of contact surface	Poor feeding, further leading to arc instability

#### 4.2 Regular inspection

**ATTENTION: To ensure safety, regular inspections must be carried out by professionals. Regular inspection must be carried out after the power supply of the distribution box and the unit is turned off to avoid causing electric shock, burns and other personal injuries. Because of the capacitor discharge, it is necessary to cut off the power supply of the welder and wait for 5 minutes before inspection.**

	<p><b>CAUTION</b></p> <p>All maintenance and repair work must be done with the power completely disconnected. Please make sure the power is unplugged before opening the housing. When the welder is energized, keep your hands, hair and tools away from the live parts inside such as fan in case of personal injury or damaging the welder.</p>
	<p><b>PERIODICAL INSPECTION</b></p> <p>Check the internal circuit connection of the welder regularly to make sure that the circuit connection is correct and the connection head is firm (especially the insert connector or component). If rust or looseness is found, sand paper should be used to grind off the rust layer or oxidation film, reconnect it and tighten it. Check all cable insulated leathers regularly for any breakage, or else bind up or replace the cable.</p>
	<p><b>BEWARE OF STATIC ELECTRICITY</b></p> <p>To avoid electrostatic damage to semiconductor components and circuit boards, please wear anti-static devices, or by touching the metal parts of the case to remove static electricity beforehand touching the wiring conductor and circuit board inside the welder.</p>
	<p><b>KEEP DRY</b></p> <p>Avoid water or water vapor entering the welder. Dry it if damped inside. Then, measure the insulation of the welder with an ohmmeter (between the connection nodes and between the connection point and the housing). Be aware that continuous welding is performed only when no abnormalities are found. If the welder is idle for a long time, put it in the original packaging case and stored in a dry environment.</p>
	<p><b>PAY ATTENTION TO MAINTENANCE</b></p> <p>To ensure the long-term normal use of the equipment, regular inspection must be carried out. Regular inspection should be meticulous, including internal inspection and cleaning of the equipment. Regular inspection is usually carried out once every 6 months, but if the welding site is full of dust or oily fumes, it is shortened to once every 3 months.</p>
	<p><b>BEWARE OF CORROSION</b></p> <p>Please use neutral deergent when cleaning plastic parts</p>

# Chapter V Troubleshooting

## 5.1 Welder failure and problems in welding procedure

Table MIG Series Failure and Problems in Welding Procedure

Fault	Troubleshooting
The power indicator light/meter does not light up; the fan refuses to work; there is no welding output.	<ul style="list-style-type: none"> <li>a. Check whether the power network pressure is normal.</li> <li>b. Check for reliable connection between the input cable and the power switch.</li> <li>c. Check for normal ON/OFF of the power switch.</li> </ul>
The torch switch does not work when pressed and the protection light is off.	<ul style="list-style-type: none"> <li>a. Check whether the panel function light and the digital meter are on;</li> <li>b. Check whether the torch switch is in good contact and the torch interface is connected.</li> <li>c. Check the contact of the wire feeder interface.</li> <li>d. Check whether the six-core control cable of the separately type machine is damaged.</li> </ul>
When pressed, the torch gun switch sends out gas and the wire feeder is normal; there is no current output and the protection light is off.	<ul style="list-style-type: none"> <li>a. Check whether the earth wire is in good contact.</li> <li>b. Check whether the wire feeder cable is correctly connected or damaged.</li> <li>c. Check the torch for damage.</li> </ul>
The torch switch starts welding but the current is high, the voltage unable to modulate, and the no-load voltage too high.	<ul style="list-style-type: none"> <li>a. Check the wire feeder control cable for breakage.</li> <li>b. There is defect in the welder control panel.</li> <li>c. Check the voltage and current feedback lines for breakage.</li> </ul>
The torch switch starts welding but the voltage is maximum and non-adjustable. The feeding speed is adjustable.	<ul style="list-style-type: none"> <li>a. Check the voltage and current feedback lines for breakage.</li> <li>b. There is defect in the welder control panel.</li> </ul>
The torch switch sends out gas and there is current output, but the wire feeder does not work.	<ul style="list-style-type: none"> <li>a. Check the wire feeder control cable for breakage.</li> <li>b. Check whether the wire feeder is struck.</li> <li>c. There is a problem about the wire feeding power.</li> <li>d. The wire feeder is damaged.</li> </ul>



The welding current is unstable, varying from high to low.	<ul style="list-style-type: none"> <li>a. Check whether the torque knob of the wire feeder is appropriate.</li> <li>b. Check whether the wire feed roll match with the welding wire/stick.</li> <li>c. Check whether the torch wire liner is heavily worn.</li> <li>d. Check whether the torch contact tube is seriously worn.</li> <li>e. Confirm the welding stick quality.</li> </ul>
The protection effect of the weld bead is not good after welding.	<ul style="list-style-type: none"> <li>a. Check the gas pressure reducing valve for heating up.</li> <li>b. After welding, keep the torch in the original position so that the gas can protect the high temperature weld bead.</li> <li>c. Prolong the shielding gas lagtime and contact the manufacturer.</li> </ul>
<b>Fault</b>	<b>Troubleshooting</b>
The gas meter does not heat up.	<ul style="list-style-type: none"> <li>a. Check whether the heating power voltage is normal.</li> <li>b. The heater plug is not inserted in place.</li> <li>c. Check whether the resettable fuse inside the welder is intact.</li> <li>d. The electric heater inside the gas meter is damaged.</li> </ul>
When the torch switch is pressed down, the welding stick is fed normally but the solenoid valve is not energized.	<ul style="list-style-type: none"> <li>a. The control panel is damaged.</li> <li>b. The solenoid valve is blocked up or damaged.</li> <li>c. The socket connecting the control panel in loosely contacted.</li> </ul>
The torch is normal but can only weld low current.	<ul style="list-style-type: none"> <li>a. Check whether the input power cord is too thin and too long.</li> <li>b. Check whether the output cable is too thin and too long.</li> <li>c. The main control panel is damaged.</li> </ul>
The weld produces massive pores.	<ul style="list-style-type: none"> <li>a. The gas is impure.</li> <li>b. The weld is full of oil stains or rust.</li> <li>c. The wind is too strong at the welding site.</li> <li>d. No gas protection.</li> </ul>
Wire is fed without pressing the torch switch.	<ul style="list-style-type: none"> <li>a. The welding torch switch is damaged.</li> <li>b. The wire feeder control line is short-circuited.</li> <li>c. The manual feeding button is damaged.</li> <li>d. The main control panel is damaged.</li> </ul>

If a fault that cannot be handled is encountered, please notify our local agent of it for maintenance and treatment.

## 5.2 After-sales service

**Warranty card:** Please read the warranty card carefully, fill it out, and keep it properly.

**Maintenance:** Please refer to Table 5.1 for welder failure and problems in welding technology, or contact your local dealer.

Our company promises to guarantee the product for one year. The warranty period is based on the purchase time recorded on the warranty card or purchase invoice. If the damage is caused due to abnormal use, it is beyond the scope of warranty but can be handled in a maintenance way.